

**jaga**



*Eyecatchers*

**IGUANA ANGULA PLUS**

€ 2016-2017.EX



*Eyecatchers*  
\* From design to art \*

## IGUANA ANGULA PLUS

A child's drawing of the sun  
shining.

Warmth with a symbolic value. Inspired by a child's drawing, an interpretation of the brightly shining sun, transformed into a fully functional work of art.

A radiator around the corner. Great capacity in a small space. A special solution, both energy-wise and aesthetically!



Top 10  
Design  
Award  
Winner  
2000

ISH 1999  
DESIGN PLUS  
Small History Year

IGUANA ANGULA traffic white 333





# IGUANA ANGULA PLUS

EN 442

DIMENSIONS (in cm)

## ANGULA PLUS / CR

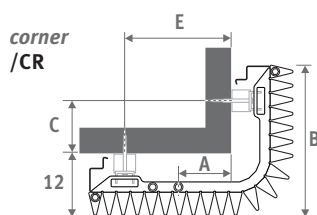

## ANGULA PLUS / CL

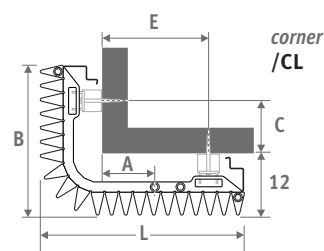

L	A	B	C	E
40.0	10.5	29.0	10.0	21.0
45.5	13.0	34.5	15.5	26.5
51.0	16.0	40.0	21.0	32.0

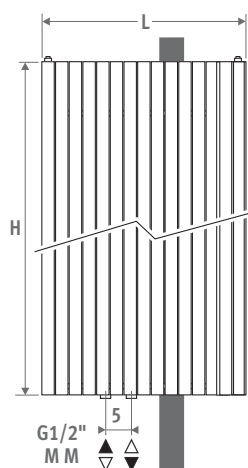
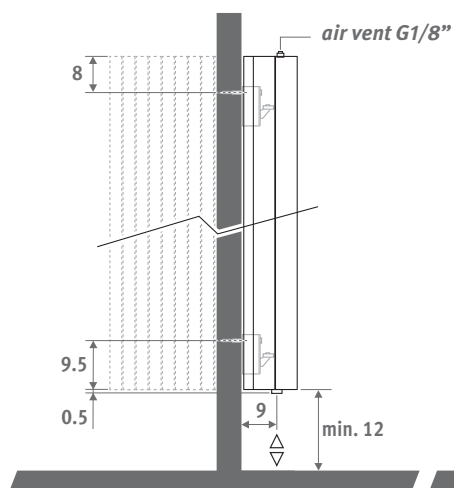

## DELIVERY

- central connection MM underneath
- wall fixing
- 2 chrome-plated air vents G1/8"
- 2 side panels

## COLOURS

Environmentally friendly, scratch-resistant, high UV resistant powder coating.

Standard colours:

- traffic white RAL 9016 (333), smooth satin matt
  - sandblast grey (001), fine texture metallic
- Other colours: see colour chart.

## CONNECTION

Top connection:

specify code 45 or 54 instead of MM (1° number is flow).

No insert pipe should be ordered. Provide an air vent on the central heating pipework.

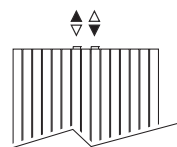

One pipe connection:

connection sets 41, 42, 48 or 49.  
Max. 2 radiators per heating ring.



## CONNECTION SETS

To guarantee the output of the Iguana models and to limit the pressure drop, Jaga recommends the use of 15/1 minimum diameter pipes.

### Connection set to the wall with a Deco-Pro valve

TRV head and sleeve couplings included.



set 48	<b>BRUSHED STAINLESS STEEL</b>	€
	CODE.PW3.PS.1...	215,80
set 41	<b>CHROME</b>	€
	CODE.PW3.DW.1...	147,90
	CODE.PW3.DC.1...	158,70

fill in sleeve coupling code

Precision metal tube 15/1	115
Precision metal tube 16/1	116
Precision metal tube 18/1	118
RPE/ALU tube 16/2	316
RPE/ALU tube 18/2	318

### Other connections:

See chapter "Connection sets and valves" for all connection options and technical information

*Iguana+*  
COLLECTION  
40% more warmth

# IGUANA ANGULA PLUS



code height length colour conn. corner  
**ANPW . 180 040 . XXX /MM /XX**  
 fill in colour code —┘  
 CL or CR —┘

	Watts 75/65	Watts 55/45	€ st. colour	€ other
<b>L H 180</b>				
040	1745	873	1118,80	1342,60
046	2078	1040	1301,60	1561,90
051	2410	1206	1483,80	1780,60
<b>L H 192</b>				
040	1823	918	1189,20	1427,10
046	2170	1093	1369,70	1643,70
051	2517	1267	1550,30	1860,40
<b>L H 220</b>				
040	1978	1010	1326,20	1591,50
046	2355	1203	1517,30	1820,70
051	2732	1396	1709,30	2051,20
<b>L H 240</b>				
040	2066	1066	1398,70	1678,40
046	2460	1270	1600,70	1920,90
051	2854	1473	1801,80	2162,30

EN442 output at 20°C room temperature

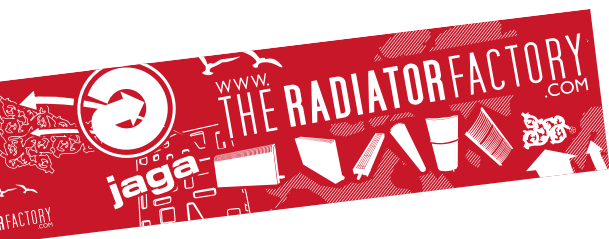

Jaga International  
Verbindingslaan z/n  
B-3590 Diepenbeek

Tel.: +32 (0)11 29 41 16  
Fax: +32 (0)11 29 41 60  
export@jaga.be

The information in this price list is correct at the time of printing.  
Jaga reserves the right to change product specification at any time in line  
with our policy of continuous improvement and innovation.  
All prices in Euro, exclude VAT. Prices valid from 1 August 2016.  
Replaces all existing price lists.